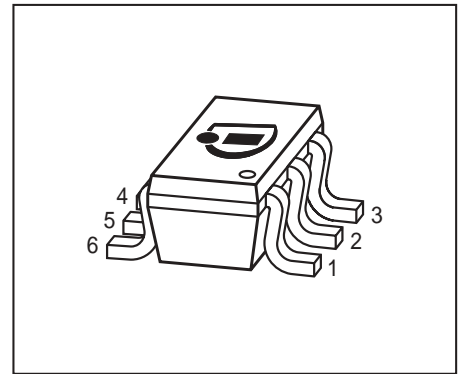
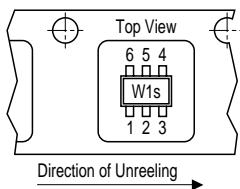

NPN / PNP Silicon AF Transistor Array

- High breakdown voltage
- Low collector-emitter saturation voltage
- Two (galvanic) internal isolated NPN/PNP Transistor in one package
- Pb-free (RoHS compliant) package ¹⁾
- Qualified according AEC Q101

Tape loading orientation

Marking on SC74 package (for example W1s) corresponds to pin 1 of device

Position in tape: pin 1 opposite of feed hole side

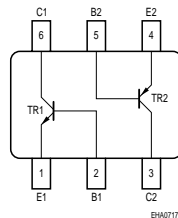

Type	Marking	Pin Configuration						Package
SMBTA06UPN	s2P	1=E	2=B	3=C	4=E	5=B	6=C	SC74

Maximum Ratings

Parameter	Symbol	Value	Unit
Collector-emitter voltage	V_{CEO}	80	V
Collector-base voltage	V_{CBO}	80	V
Emitter-base voltage	V_{EBO}	4	V
Collector current	I_C	500	mA
Peak collector current	I_{CM}	1	A
Base current	I_B	100	mA
Peak base current	I_{BM}	200	mA
Total power dissipation- $T_S \leq 115^\circ\text{C}$	P_{tot}	330	mW
Junction temperature	T_j	150	$^\circ\text{C}$
Storage temperature	T_{stg}	-65 ... 150	$^\circ\text{C}$

¹⁾Pb-containing package may be available upon special request

Thermal Resistance

Parameter	Symbol	Value	Unit
Junction - soldering point ¹⁾	R_{thJS}	≤ 105	K/W

Electrical Characteristics at $T_A = 25^\circ\text{C}$, unless otherwise specified

Parameter	Symbol	Values			Unit
		min.	typ.	max.	

DC Characteristics

Collector-emitter breakdown voltage $I_C = 1 \text{ mA}, I_B = 0$	$V_{(BR)CEO}$	80	-	-	V
Collector-base breakdown voltage $I_C = 100 \mu\text{A}, I_E = 0$	$V_{(BR)CBO}$	80	-	-	
Emitter-base breakdown voltage $I_E = 10 \mu\text{A}, I_C = 0$	$V_{(BR)EBO}$	4	-	-	
Collector-base cutoff current $V_{CB} = 80 \text{ V}, I_E = 0$ $V_{CB} = 80 \text{ V}, I_E = 0, T_A = 150^\circ\text{C}$	I_{CBO}	-	-	0.1 20	μA
Collector-emitter cutoff current $V_{CE} = 60 \text{ V}, I_B = 0$	I_{CEO}	-	-	100	nA
DC current gain ²⁾ $I_C = 10 \text{ mA}, V_{CE} = 1 \text{ V}$ $I_C = 100 \text{ mA}, V_{CE} = 1 \text{ V}$	h_{FE}	100 100	- -	- -	-
Collector-emitter saturation voltage ²⁾ $I_C = 100 \text{ mA}, I_B = 10 \text{ mA}$	V_{CEsat}	-	-	0.25	V
Base-emitter voltage ²⁾ $I_C = 100 \text{ mA}, V_{CE} = 1 \text{ V}$	$V_{BE(ON)}$	-	-	1.2	

AC Characteristics

Transition frequency $I_C = 20 \text{ mA}, V_{CE} = 5 \text{ V}, f = 20 \text{ MHz}$	f_T	-	100	-	MHz
Collector-base capacitance $V_{CB} = 10 \text{ V}, f = 1 \text{ MHz}$	C_{cb}	-	7	-	pF

¹⁾For calculation of R_{thJA} please refer to Application Note Thermal Resistance

²⁾Pulse test: $t < 300\mu\text{s}; D < 2\%$

DC current gain $h_{FE} = f(I_C)$

$V_{CE} = 1\text{ V}$

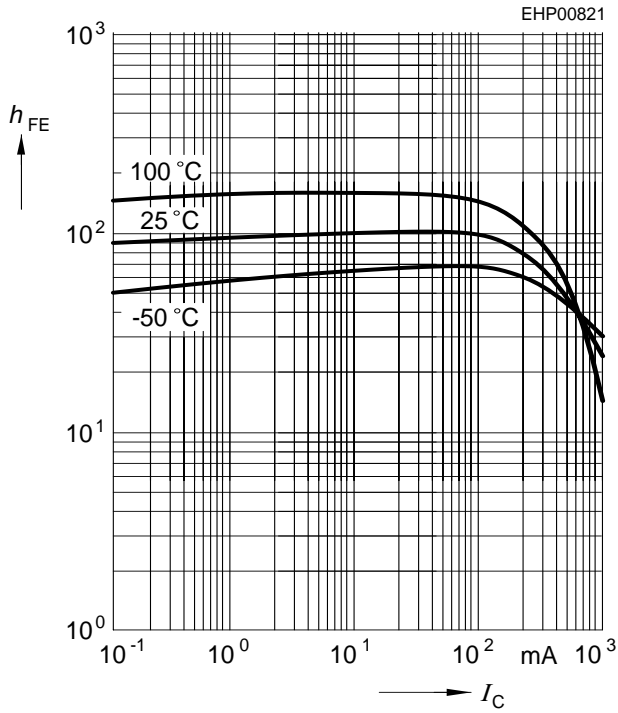

Collector-emitter saturation voltage

$I_C = f(V_{CEsat}), h_{FE} = 10$

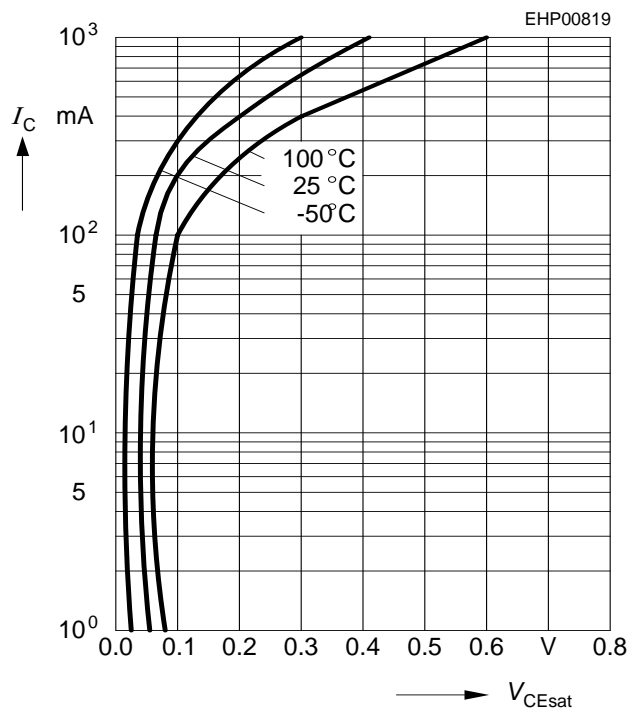

Base-emitter saturation voltage

$I_C = f(V_{BEsat}), h_{FE} = 10$

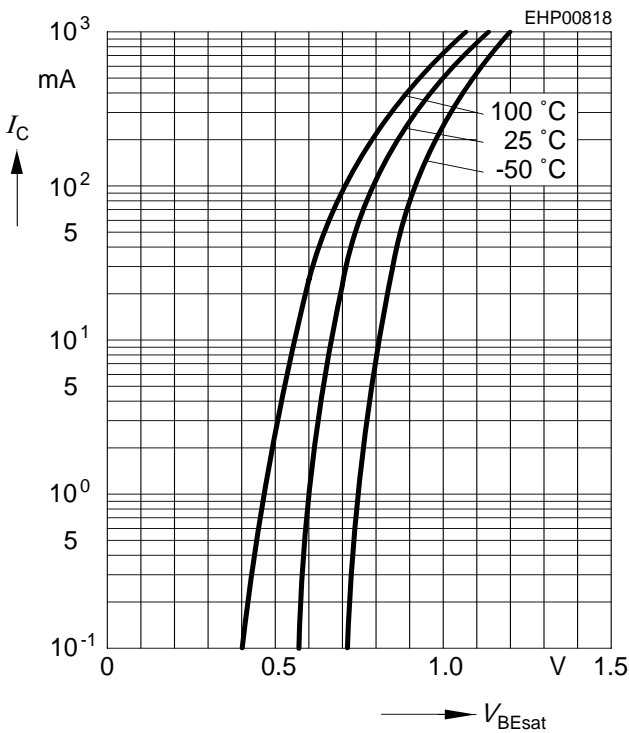

Collector current $I_C = f(V_{BE})$

$V_{CE} = 1\text{ V}$

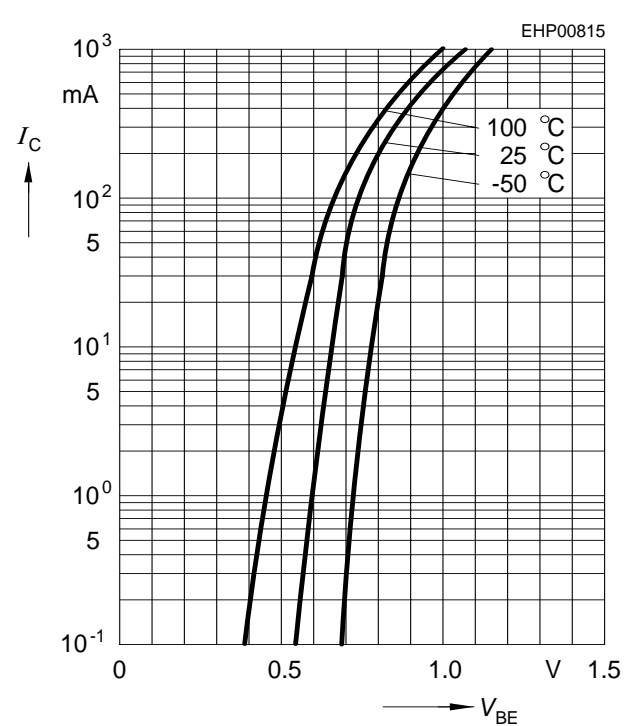

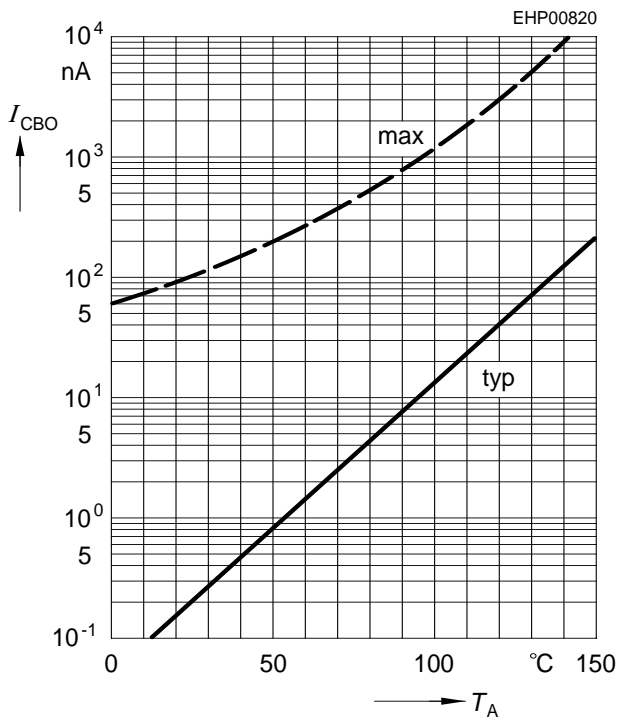
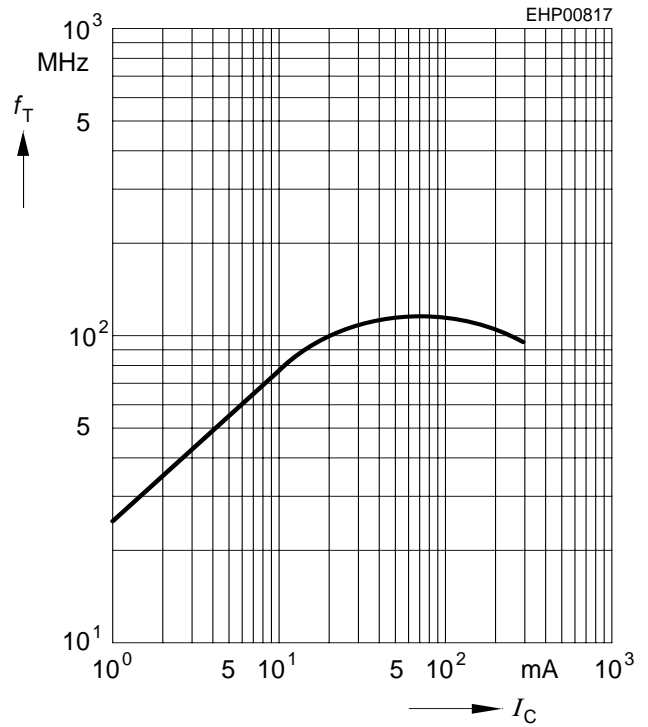
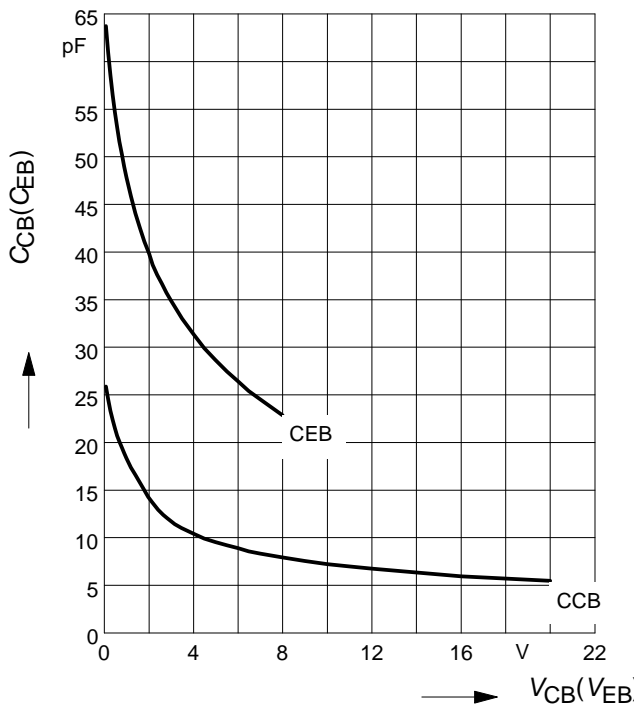
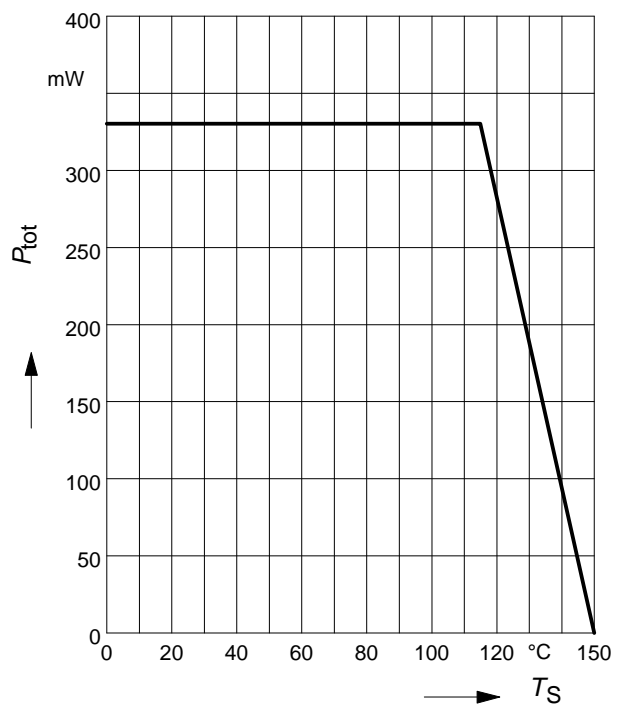
Collector cutoff current $I_{CBO} = f(T_A)$
 $V_{CBO} = 80 \text{ V}$

Transition frequency $f_T = f(I_C)$
 $V_{CE} = \text{parameter in V, } f = 2 \text{ GHz}$

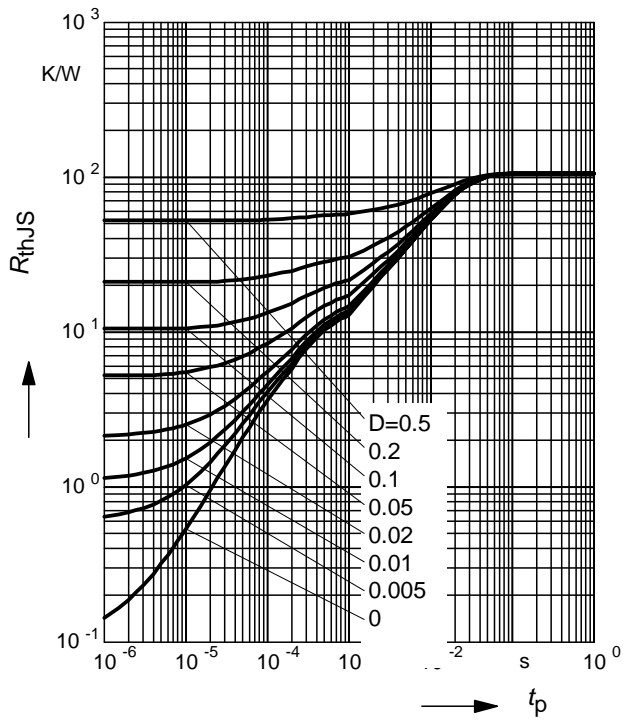
Collector-base capacitance $C_{cb} = f(V_{CB})$
Emitter-base capacitance $C_{eb} = f(V_{EB})$

Total power dissipation $P_{tot} = f(T_S)$

Permissible Pulse Load $R_{thJS} = f(t_p)$

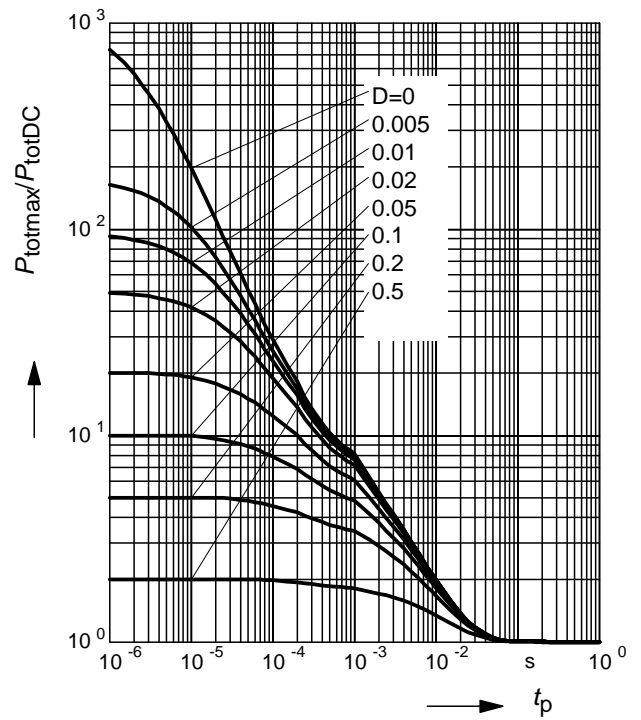

Permissible Pulse Load

$P_{totmax}/P_{totDC} = f(t_p)$



Package Outline



Foot Print



Marking Layout (Example)

Small variations in positioning of Date code, Type code and Manufacture are possible.



Standard Packing

Reel \varnothing 180 mm = 3.000 Pieces/Reel
 Reel \varnothing 330 mm = 10.000 Pieces/Reel

For symmetric types no defined Pin 1 orientation in reel.



Edition 2006-02-01

Published by

Infineon Technologies AG

81726 München, Germany

© Infineon Technologies AG 2007.

All Rights Reserved.

Attention please!

The information given in this dokument shall in no event be regarded as a guarantee of conditions or characteristics ("Beschaffenheitsgarantie"). With respect to any examples or hints given herein, any typical values stated herein and/or any information regarding the application of the device, Infineon Technologies hereby disclaims any and all warranties and liabilities of any kind, including without limitation warranties of non-infringement of intellectual property rights of any third party.

Information

For further information on technology, delivery terms and conditions and prices please contact your nearest Infineon Technologies Office (www.infineon.com).

Warnings

Due to technical requirements components may contain dangerous substances. For information on the types in question please contact your nearest Infineon Technologies Office.

Infineon Technologies Components may only be used in life-support devices or systems with the express written approval of Infineon Technologies, if a failure of such components can reasonably be expected to cause the failure of that life-support device or system, or to affect the safety or effectiveness of that device or system.

Life support devices or systems are intended to be implanted in the human body, or to support and/or maintain and sustain and/or protect human life. If they fail, it is reasonable to assume that the health of the user or other persons may be endangered.